

BIG TOP PARTY RENTAL
36 Hillman Street, Unit 4
Tewksbury, MA 01876
(978) 858-0250
www.bigtoppartyrental.com

Place
Stamp
Here

TO:

Four vertical lines for an address.



“Invite us to your next party”

BIG TOP

PARTY RENTAL

TEWKSBURY, MA
“Invite us to your next Party”

Celebrating 30 Years in Business Since 1992

36 Hillman Street - Unit 4 - Tewksbury, MA 01876

2021 PARTY PRICE LIST

- *• Birthday Parties*
- *• Weddings*
- *• Graduations*
- *• Business Promotions*
- *• Tent Sales*
- *• Fundraisers*
- *• Barbecues*
- *• Restaurant Tenting*

“Not only are Big Top’s prices low, we also deliver and set up. We buy only the finest quality products and equipment.”

- Party Tents • Tables • Chairs • Dance Floors
- Kwik Covers • Karaoke Machines
- Glassware • Dinnerware • Misting Fans • Bar Stools
- BBQ Grills • Popcorn & Cotton Candy Machines
- Bistro Lighting • Chocolate Fountain
- Casino Games • Staging • Coolers • Pipe and Drape
- Christmas Lights Sales and Installations
- Projectors and Projection Screens • Sky Dancers
- Dunk Tanks • Spin Art • & Much More!

Visit our website for more information

www.bigtoppartyrental.com

Call (978) 858-0250



Serving all of New England. Located in Tewksbury, MA

Quality • Quantity • Low Rates • Since 1992

“We Will Gladly Email You An Estimate. It Only Takes A Minute”

Visit our "Policies and FAQ" page at www.bigtoppartyrental.com

"We at Big Top Party Rental do whatever it takes to satisfy our customers. If something you need is not listed in our price guide don't hesitate to ask. We deliver and set up anywhere, anytime. Consider us your Party Consultants at no extra charge. Thank you for your interest in our company. We will make your party the best."

Store Hours: 8:30 to 5:00 Monday - Friday
Open some Saturdays during the summer.

Big Top Party Rental

36 Hillman St., Unit 4 • Tewksbury, MA 01876

Phone (978) 858-0250 • Fax (978) 858-0029 • Cell (978) 505-0077

** Please only call cell for after hour emergencies or if you need a rental within 72 hours.*

www.bigtoppartyrental.com Email: bigtopparty@comcast.net

**Emailed orders are not accepted due to confirming availability.*

We accept all major credit cards.



Tent Accessories: We Set Up & Deliver

TENT SIDEWALLS

- Sidewalls (White Solid) 20 ft sections 30.00
- Sidewalls (White with Windows) 20 ft sections 30.00
- Sidewalls (White Mesh Screen) 20 ft sections 35.00

FANS

- Fan- 12 inch Tent fan 50.00
- Fan - 20 inch (Tri-pod Stand) 70.00
- NEW!** Misting Fan 18" "Cool Caddie" (No Hose Needed, 16 Gallon Tank) ... 149.00
- Big Ass Fan, Sidekick (48" diameter on wheels, 7.5 AMPS) 175.00

TENT LIGHTING

- NEW!** Light Dimmer for Tent (Two 7 AMP outlets)..... 40.00
- Lighting, Perimeter LED for Tents (120 ft per set)) 55.00
- Lighting, LED Floodlight with Remote (18 Colors) 90.00
- Lighting, Par 38 (Tent Flood Light LED) Goes on Center Poles 90.00

TENT HEATERS

- Tent Heater (80,000 BTU, Requires Propane)..... 150.00

**12 gauge Extension Cords are recommended for all Fans, Lighting & Heaters.*

MISCELLANEOUS

- Barricades (8' 4" x 44"h) 25.00
- Exit Sign (Lights Up) 60.00
- Fire Extinguisher (5 lb. - ABC) 15.00
- *Refill Charge of \$50 will apply if used*
- Water Barrels (55 or 75 Gallon) 22.00
- Block N' Roll (350 lbs) 25.00

We now offer Bistro Lighting! Call for pricing.
Great for patios, decks, driveways and pool areas!

Tents: We Set Up & Deliver

Don't let the rain or heat stop you from having your party. Stay cool and dry under one of Big Top's tents. **Always allow an additional 10 feet to each dimension for staking.** Visit the "Party Tips" page on our website if you are uncertain of the tent size or space you will need. The prices below include set up. Sidewalls are not included and rented separately.

ALL WHITE POLE TENTS

- | | |
|--------------------------------------|--------------------------------------|
| 20' x 20' (40 people)..... 315.00 | 30' x 90' (260 people)..... 1,650.00 |
| 20' x 30' (60 people)..... 395.00 | 30' x 105' (300 people).... 1,950.00 |
| 20' x 40' (80 people)..... 475.00 | 40' x 40' (160 people)..... 1,250.00 |
| 30' x 30' (90 people)..... 750.00 | 40' x 60' (240 people)..... 1,650.00 |
| 30' x 45' (140 people)..... 950.00 | 40' x 80' (320 people)..... 2,050.00 |
| 30' x 60' (180 people)..... 1,150.00 | 40' x 100' (400 people).... 2,450.00 |
| 30' x 75' (220 people)..... 1,350.00 | 40' x 120' (480 people).... 2,850.00 |

**Pole tents are held up by tension. These tents all have center poles and require anywhere from 12 to 30 stakes per tent. Pole tents can only be set up over grass or pavement. Additional charges will apply if set up on pavement. Call for larger tent sizes.*

ALL WHITE FRAME TENTS

- | | |
|------------------------------------|--------------------------------------|
| 10' x 10' (10 people) 200.00 | 20' x 20' (40 people)..... 425.00 |
| 10' x 20' (20 people) 300.00 | 20' x 30' (60 people)..... 525.00 |
| 10' x 30' (30 people) 400.00 | 20' x 40' (80 people)..... 625.00 |
| 12' x 12' (15 people) 235.00 | 30' x 30' (90 people) 950.00 |
| 15' x 15' (22 people) 315.00 | 30' x 45' (140 people)..... 1,450.00 |
| 15' x 30' (45 people) 515.00 | 30' x 60' (180 people) 1,950.00 |
| 15' x 45' (60 people) 715.00 | 30' x 75' (200 people) 2,450.00 |

Frame tents are held up by a pipe structure and require minimal staking. They have no center poles and require anywhere from 4-16 stakes per tent. **Frame tents can be set up on any surface such as grass, pavement, concrete, or patios. Water barrels can sometimes be used to anchor these tents for those who prefer not to stake. Customer must order water barrels at time of placing order.*

PINK FRAME TENT **NEW!**

- 20' x 20' Pink Frame Tent (40 People) 400.00

**Great for breast cancer awareness events, sweet 16, princess birthdays, showers, and more!*

EZ-UP CANOPY

- 10'x10' White Tent (Specify grass or pavement installation when ordering) 120.00

DO IT YOURSELF PARTY TENTS

- 16' x 16' (White) 149.00

**The "Do It Yourself Tents" are a more affordable tent that we allow our customers to install themselves. We do not offer set up with these tents. All "Do It Yourself Tents" come with easy set up instructions. Two handy people and a 10 pound sledgehammer is all it takes to install these tents! *DIY tents require grass installation only.*

“Tables, Chairs, Table Covers, Dance Floors, Staging, Pipe & Drape”

TABLES, CHAIRS & UMBRELLAS

4' Banquet Table 30" x 48" (seats 4-6).....	12.00
6' Banquet Table 30" x 72" (seats 6-8).....	12.00
8' Banquet Table 30" x 96" (seats 8-10).....	12.00
30" x 30" Square Table (specify 30" or 42" height).....	12.00
30" Round Cocktail Table (42" high).....	12.00
36" Round Cocktail Table (42" high).....	12.00
NEW! Table Lamp (Rechargeable, 11", LED).....	9.00
30" Round Table (seats 2-4 people).....	12.00
36" Round Table or 3 ft. Round (seats 4-5 people).....	12.00
48" Round Table or 4 ft. Round (seats 4-6 people).....	12.00
60" Round Table or 5 ft. Round (seats 8-10 people).....	12.00
Serpentine Table 30" x 60" (30" high).....	12.00
6' Classroom 18" x 72".....	12.00
Blue Folding Chairs.....	1.50
White Folding Chairs.....	2.25
NEW! White Resin Garden Chairs.....	4.00
Bar Stool (Black Folding, 28.5" High).....	3.25
Table Umbrella - Green 90" (*Table Not Included).....	35.00
60" Round Umbrella Table.....	14.00
Riser for Serpentine Table.....	12.00
Riser for 6' Table.....	12.00



CHILDRENS TABLES & CHAIRS

Childrens Table, Blue Plastic (20" height, seats 6-10).....	12.00
Childrens Folding Chair (Blue Plastic, Metal Frame).....	1.75
Wooden High Chair.....	15.00
Booster Seat.....	8.00

LINEN TABLE COVERS

Linen (Over 60 different colors available)*Call for Prices and Sizes*

KWIK COVERS TABLE COVERS

Kwik Covers (All sizes).....	3.95
Kwik Cover (4ft Fill N' Chill, White).....	4.00
Kwik Cover (6ft Fill N' Chill, White).....	5.00
Kwik Cover (Water Barrel).....	3.50

**Our NEW Kwik Covers are reusable or disposable. They are quick & easy to install. These wind proof elastic corners hold table cover on tight without using tacks, staples or tape. We always stock white, for additional colors, please call.*

DANCE FLOORS

Parquet 4' x 4' Sections: Indoor.....	24.00	Outdoor.....	26.00
---------------------------------------	-------	--------------	-------

**We can create any size that you desire. Email us for a list of sizes and prices.*

STAGING

4' x 4' Sections (9"-24" high).....	38.00	<i>*Our staging can be adjusted between 9"-24" high. Please specify when ordering.</i>
Stairs w/ rail.....	38.00	<i>Stairs and Skirting are rented separately.</i>
Stage Step.....	30.00	
Stage Skirting (Black - 8' X 15' or 24' Sections)...	10.00	

“Food Machines are a great addition to any event or Fundraiser”

FOOD MACHINES

We do not require you to clean any of our food machines after you use them. Leave us the mess at no extra charge!

Chocolate Fountain (Shasta 23" height).....	150.00	
<i>*Holds 5lb minimum and 8 lb maximum of chocolate.</i>		
Chocolate Un-melted: Dark (1.7 lbs/bag).....	14.00	
<i>*Each bag will feed 20 people. No returns allowed on unused chocolate. We recommend using 4 bags when in use.</i>		
Chocolate Liquid: Milk (6 lb container).....	36.00	
<i>*Each 6 lb container will feed 60 people.</i>		
Coffee Maker (60 cups).....	25.00	
Cupcake Tower (26" tall, Round, 2-5 tiers, holds up to 140) ..	28.00	
Cotton Candy Machine.....	55.00	
Cotton Candy Supplies (per 50).....	17.00	
<i>*Cotton Candy supplies come with bags, cones and sugar (blue or pink)</i>		
NEW! Cotton Candy Pre-made Bags (9" X 13" cello bag)	2.00	
<i>*Great if you don't want to rent the machine. Available in Pink or Blue.</i>		
Cotton Candy Cart.....	30.00	



Frozen Beverage Machine (1 Bowl Unit).....125.00

**Frozen Beverage Supply pricing is available by email or calling our office. We have Strawberry Daiquiri, Blue Raspberry, Margarita and Pina Colada available.*

NEW! Hot Dog Steamer (holds 80)	42.00
Lemon Squeezer.....	25.00

**Ask about our Lemonade Stand!*

NEW! 1 Gallon Sugar Water (makes 4 Gallons of Lemonade) ..	22.00
Pizza Warmer (18" x 18" x 30")	65.00

**Holds up to (4) Large Pizzas; includes pans.*

Pizza/Pretzel Combo Unit.....	65.00
<i>*Holds (2) Pizzas and up to (20) Pretzels.</i>	

Popcorn Machine.....55.00

Popcorn Machine supplies (per 50) Bags, oil & seed.....17.00

Popcorn Machine supplies (per 50) Boxes, oil & seed.....20.00

Popcorn Cart.....30.00

NEW! Pretzel Warmer (18" x 18" x 30").....	65.00
---	-------

**Holds up to (50) Pretzels!*



Snowie, 1000 Model..... 59.00

Snowie Supplies (per 25)..... 22.00

**Snowie supplies come with 25 cups, spoon straws & 2 flavors. Ice not included.*

Ask about our available flavors. Extra Flavors are \$9.50 (32oz. bottle).

Extension Cords (100 feet, 12 gauge, 3 prong white cord)..... 11.00

IMPORTANT: We recommend you only use a 12 gauge, 3 prong extension cord with any of our food machines. Do not use more than a 100 feet of extension cord or machine may not work properly. We do have extension cords available for rental. We also strongly recommend not using any splitters or adapters.



"Cookout & BBQ Equipment"

COOLERS & BEVERAGE SERVERS & WARMERS

Beverage Dispenser (5 Gallon) 18.00
**Our Beverage Dispensers are great for lemonade, iced tea, hot chocolate, punch, hot or cold water. Green, Black and Blue colors available.*



NEW! Cambro 4-Pan Food Warmer, Black (Holds 4 pans)..... 40.00

Coffee Carafe, 40 oz 3.50

Fill N' Chill Party Table, 6ft Black (Holds 75-100lbs of ice) 30.00

Fill N' Chill Party Table, 4ft White (Holds 35-50lbs of ice)..... 22.00

**Keeps salads, drinks, dessert, and meats cold and fresh! Skirting is rented separately. Ask about Kwik Covers!*

Fill N' Chill Skirting and Skirt Clips 12.00

NEW! Lemonade Bar/Stand 150.00

**Includes Umbrella, (2) 18 Quart Coolers, Cutting Board and Bottle Opener*

Marine Cooler, White (102 Qt) 22.00

**Our Marine coolers are great for keeping food, ice or drinks cold. Holds over 150 cans.*

Portable Bar 85.00

Super Coolers 20.00

**Holds 7 cases of cans or any size keg. Only needs 3-4 bags of ice!*



GRILLS & COOKERS

Chafing Dishes, Half Size 4 Qt 20.00

Chafing Dishes, Full Size 8 Qt 25.00

Additional Food Pans available, 4 qt 4.50, 8 qt 7.00

Chafing Dish Roll Top, Full Size 9 Qt..... 49.00

Sternos for Chafing Dishes(1 can per every 4 Qt)..... 2.25

Charcoal Grill (2 x 5, charcoal not included)..... 95.00

Gas Grill (2 x 4, propane not included) 130.00

Grill Kit (Tongs, Spatula, Lighter, Cleaning Brush, & Fork) 9.00

Pot, Basket & Lid (60 Qt) 25.00

Single Burner Pot Cooker (propane not included) 22.00

Gas Griddle (propane & fire extinguisher not included) .. 130.00

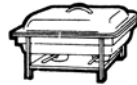

"Propane Tank Rental Prices Are On Miscellaneous Page"

**All of our Coolers, Chafing Dishes, Pots, Portable Bars and Beverage Dispensers must be returned reasonably clean. A service charge will apply if any of these items are returned not clean.*

DUNK TANKS & BIG SPLASH

Dunk Tank Purple 225.00

**Our Dunk Tanks holds 500 gallons of water and takes roughly about 30-40 minutes to fill.*

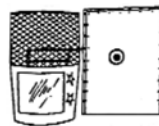

Dunk Tank

NEW! Big Splash (A great substitution for the Dunk Tank) ... 149.00

"Games, Trade Shows & Fundraising Items"

GAMES

NEW! Cornhole Game (visit our website for more info)..... 45.00

NEW! Hole in One Golf Game 95.00

NEW! Jumbo Beer Pong 25.00

**Includes (12) Buckets, (2) balls & Carry Case.*

NEW! Jumbo Jenga 45.00

Jumbo Connect 4 45.00

Limbo Game (rack with music CD) 25.00

Potato Sack Race Set 25.00

Spin Art Machine 55.00

Spin Art Supplies (per 50) 37.50

Tug of War Game 20.00

Mini Hoops 45.00

Ring Toss 45.00

Tic Tac Toss 45.00

**Recommended ages for Ring Toss, Tic Tac Toss & Mini Hoops is 12 and under.*

"For A List Of Casino Games See Page 9"

TRADE SHOW & FUNDRAISING ITEMS

Raffle Drum..... 18.00

Raffle Tickets (2000 per roll) 8.00

Prize Wheel - Table Top (30" Diameter) 79.00

**12 customizable prize slots. Dry erase or insert.*

NEW! Easel (Aluminum, Telescopic, Folding, 64 1/4" H)..... 14.00

PIPE, DRAPE & STANCHIONS

Base Plates (15" x 15" Screw In, 12lbs).....5.00

Base Plates (18" x 18" for Adj. Uprights, 18lbs)9.00

Base Weight (25lbs)16.00

Uprights: 8 Ft High (Screw in)..... 5.00 3 Ft High (Screw in)5.00

Adjustable (6'-10') 15.00 2 Ft Upright Extender ..4.00

Crossbars (6', 8', or 10' Adjustable)5.00

Sign Hooks for Crossbars (Pack of 10).....2.00

For pricing and colors of drape please call our office.

Red Carpet (4' x 25')99.00 Red Carpet (4' x 36')..... 130.00

**Security Deposit Required on all Red Carpet rentals.*

Stanchions, Chrome Base..... 12.00 Stanchions, Rope 8' Velvet.....9.00

Stanchions, Black..... 10.00 Stanchion Sign Holder8.00

HELIUM TANKS & BALLOONS (Helium prices subject to change)

Helium Tank - 20 Cubic Foot (50-70 Balloons) 58.00

Helium Tank - 40 Cubic Foot (80-140 Balloons) 97.00

Helium Tank - 80 Cubic Foot (160-280 Balloons) 149.00

**Visit our web site for larger sizes. Balloons and Regulator are Not included.*

Balloon Assortment Pack 50 (9 inch) 16.50

**Comes with 1 roll 3/16 White Ribbon. Jewel Assorted 9 inch Balloon colors are Red, Blue, Green, Yellow & Orange.*

Helium Regulator (no gauge).... 5.00 Helium Regulator (gauge) 12.00

Balloon Ribbon (3/16, White)..... 4.00

CASINO GAMES

Have us set up a mini casino at the home or office!

Black Jack Table with Accessories	120.00
<i>*Black Jack Accessories come with 6 decks of cards, dealers shoe, discarder & chips.</i>	
Craps Table with Accessories.....	120.00
<i>*Craps Table Accessories come with 5 dice, dice stick, on/off puck & chips.</i>	
Roulette Table with Accessories.....	120.00
<i>*Roulette Table Accessories come with wheel, ball, win indicator & chips.</i>	
Chuck-A-Luck/Grand Hazard	49.00
<i>*Chips rented separately.</i>	
Casino Package	299.00
<i>*Casino Package includes Black Jack, Craps & Roulette Tables with Accessories.</i>	
Case of Chips	16.00
<i>*Chips come in \$1, \$5, \$10 & \$25 denominations. A total of 125 chips for each denomination totaling \$5,125 per case.</i>	



All Casino Accessories are rental items and must be returned.

KARAOKE

Karaoke Bravo System (has over 446 songs, 2 microphones).....	119.00
19" Television LED	19.00
<i>*Our Karaoke system does not need a sound system for crowds less than 80 people. You'll need a television to see the words displayed. Email us for song list.</i>	

SOUND SYSTEMS

 Bose Wireless Speaker (bluetooth, rechargeable 11-hour battery)	75.00
Podium or Lectern (needs electricity or two 6V batteries)	90.00
<i>*Batteries not included.</i>	
Fender P-150 PA Sound System (150 watt)	70.00
<i>* Our Fender is very easy to use. Speakers, microphone, amp and mixer all in one. Hook up to any iPod or Laptop! Additional cable for hook up rented separately.</i>	
iPOD or Laptop Mini Stereo to Dual RCA Cable	3.00
RCA Cable (9 feet)	3.00
Yamaha MSR400 Sound System (800 watt).....	195.00
Speaker Stands	10.00
<i>Use only 12 gauge, 3 prong extension cords with all visual, microphone, and sound systems</i>	



MICROPHONES

Microphone Stand	10.00
Microphone with Wire	6.00
Wireless Handheld Microphone System	45.00
Wireless Lapel Microphone System	50.00

VISUAL & EFFECTS



DVD Player.....	25.00
Projection Screen – 6 foot (indoor screen).....	70.00
Projection Screen – 10 foot (indoor screen).....	110.00
Projector – Sanyo PLC-XC55 Ultra Portable LCD	125.00
Projector – Panasonic PT-VZ580U - 5000 Lumen	125.00
Roto Balls.....	25.00
<i>*2 Multi-colored balls that spin and rotate to create 104 rich saturated razor sharp beams of light. Visit our website for a demonstration.</i>	

SKY DANCERS

Santa Air Puppet, 20'	125.00
Elf Air Puppet, 20'	125.00
 "Now Open" Air Puppet (red with yellow print).....	90.00
Air Puppet, 20' Plain.....	90.00
<i>*Colors available: Red, Yellow, Fluorescent Green, Light Blue, and Royal Blue</i>	
 Big Top Party Air Puppet, 20' (Blue with Yellow Print)	70.00
Bride Air Puppet, 18'	110.00
Congratulations Air Puppet, 20'	90.00
Corona Air Puppet, 20'.....	90.00
 Ghost Air Puppet, 18' (Lights up LED)	90.00
Grand Opening Air Puppet, 20'	90.00
Groom Air Puppet, 18'	110.00
Happy Birthday Air Puppet, 20'	90.00
Sale Air Puppet, 20' Blue	90.00
Welcome Home Air Puppet, 20'	90.00

** Blowers are included with each Sky Dancer Rental. Extension cords are additional. All prices are based on 2 days use. Sky Dancers should not be used in rain or severe winds. If you need a blower for your own Sky Dancer, we do rent them.*

MISCELLANEOUS ITEMS











Ceremonial Ribbon (Red, 4" wide, 20' long)	12.00
 Ceremonial Scissors (Silver Plated, Black Handle, 25" long)	39.00
Coat Rack, Single Rail Collapsible (Holds 40-60 garments)	18.00
Coat Hangers (Pack of 10)	2.00
Coat Check Tickets (Pack of 50)	6.00
Generator (2,000 Watt, Quiet) Honda EU2200i	59.00
 Generator (3,000 Watt, Quiet) Honda EU3000is	99.00
Generator (7,000 Watt, Quiet) Honda EU7000IAT1	165.00

**All of our generators take unleaded fuel.*

Podium or Lectern (needs electricity or two 6V batteries)	90.00				
<i>*Batteries not included.</i>					
Propane Tanks: 20 lb	23.00	40 lb	39.00	100 lb	99.00
Trash Barrels - 32 Gallon (comes with 1 liner).....	13.00				
Disposable Trash Box - (55 Gallon liner included)	12.00				
Smoker's Receptacle	60.00				

“Glassware, Dinnerware, and Flatware”

GLASSWARE

All Purpose Goblet (Water), 14 oz, (25 Per Rack)	15.00	
Champagne Flute, 5.75 oz, (36 Per Rack)	22.00	
Highball (Beverage Glass), 12.5 oz, (36 Per Rack)	20.00	
Martini (Cocktail), 10 oz, (12 Per Rack)	15.00	
Rocks Glass, 9 oz, (25 Per Rack)	15.00	
Tall Wine, 8.5 oz, (25 Per Rack)	15.00	
Tall Wine, 12 oz, (25 Per Rack)	15.00	
Irish Coffee, 10 oz (25 Per Rack)	15.00	
Water Pitcher, Glass 55 oz (5 Per Rack)	20.00	
Water Pitcher, Glass 55 oz (Individual)	5.00	
Shot Glass 2.5 oz (49 per pack)	24.50	

All of our glassware is fully tempered to be durable and safe!

DINNERWARE

Classic White Rim Collection

Classic Dinner Plate, 10¼” (20 Per Rack)	15.00
Salad/Dessert Plate, 8¾” (30 Per Rack)	18.00
B&B/Appetizer Plate, 6” (38 Per Rack)	20.00
Coffee Cup, 8 oz (20 Per Rack)	12.00
Saucer, 6” (44 Per Rack).....	24.00
Soup/Salad Bowls, 9 oz (packs of 10).....	10.00



White Square Collection

Artisan Square Dinner Plate, 10½” (20 Per Rack)	20.00
Salad/Dessert Plate, 8½” (21 Per Rack)	17.00
Bread & Butter/Appetizer Plate, 6” (44 Per Rack)	30.00
Coffee Cup, 7 oz (20 Per Rack).....	16.00
Saucer, 5” (38 Per Rack)	25.00
Platter, 15¾” x 9¾”, Porcelain (Individual)	3.00



FLATWARE - Each pack of 10 ...6.50

Dinner Fork (Pack of 10)	Dinner Spoon (Pack of 10)
Salad Fork (Pack of 10)	Soup Spoon (Pack of 10)
Dinner Knife (Pack of 10)	Table Spoon (Pack of 10)
Oyster Fork (Pack of 10)	Butter Knife (Pack of 10)



SERVING ACCESSORIES

Lobster Shell Cracker	1.00	Dolly (Tan, plastic w/ wheels)	8.00
Coffee Carafe, 40 oz, White (5 Per Rack)	17.50	Holds 4-6 Rack.....	8.00
Bread Basket, 9” x 2¾”, Round, Woven Poly, Natural Wood Color..	2.50	Cambro 4-Pan Food Warmer, Black (Holds 4 pans).....	40.00
Salt & Pepper Shaker set	1.50	Ramekins, 2 1/2 oz (each)	1.00
Serving Tray, Silver, 18” Round	12.00	Chafing Dish, Half Size 4 Qt....	20.00
Tray (Oval 22” x 27”) Black.....	15.00	Chafing Dish, Full Size 8 Qt	25.00
Tray Stand (Chrome).....	14.00	Chafing Dishes, Roll Top Full Size 9 Qt	49.00
Water Pitcher, Glass 55 oz	5.00	Sternos (8 qt needs 2 cans)	2.25
<i>If you are searching for something not on this list, just ask!</i>		Tongs (12 inch)	2.00

**Any dinnerware or flatware that is returned without being scraped/wiped is subject to a \$10 fee per rack or \$0.25 fee per piece of flatware.*

“Invite Us To Your Next Party”

About Our Rental Services

We recommend you reserve the items you need as soon as possible to ensure they will be available. Delivery charges apply and vary according to area. We also have items available for customer pick up at our location in Tewksbury. Please do not email any orders. Emailed orders are not accepted as we must check rental item availability and take a down payment at the time your reservation is placed.

Responsibility for equipment remains with customer from time of possession until time of return. Prices are quoted for one day’s use. There are shorter and longer rates available; please call for details. There will be a charge for items not returned clean and for missing or broken items. We do not require you to clean any of our food machines after you use them, however, we do require that food machines be returned empty.

Supplies for spin art, popcorn machines, casino games, chocolate fountains, cotton candy machines, Snowie machines, frozen beverage machines, coffee makers, and any other food machines are sold separately. Propane for grills, patio and tent heaters is also sold separately.

An extra charge will apply for any tent used on asphalt. We must be told at time of reservation what surface any tent will be used on because of staking concerns. Only grass or asphalt areas are acceptable. Decks or concrete surfaces are most times not acceptable. When renting tables, chairs, pipe and drape, a service charge of 25% may apply for set up.

Reservation and Cancellation Policy

Reservations: A 50% non-refundable down-payment is due at time of reservation on orders with more than 30 days before event. Full payment is due on all orders placed within 30 days of event and on all orders under \$300. So, if your order is less than \$300, you do have to pay in full at time of reservation. For orders received more than 30 days in advance and which are over \$300, payment in full is due prior to or at time of delivery.

Cancellations: All sales are final and non-refundable on orders placed within 21 days of event date. No refunds will be granted in the event of rain or inclement weather. Rental Contracts may not be terminated by the Customer within 21 days of event. If customer cancels 22 days or beyond they will be obligated to pay 50% of Rental Contract total and a \$25.00 processing fee will also apply.

Order Adjustments (Order Changes): Any quantity reductions and adjustments on rental equipment shall not be valid if not received prior to 21 days before event date by BTPR. Any order changes must be submitted to BTPR by email notice and are subject to availability and our Terms and Conditions. We need 3 weeks’ notice on all reasonable order adjustments (A 25% fluctuation is considered reasonable) regardless of when order is placed.

If you need any further clarification regarding our policies, please contact us at 978-858-0250. Our customer service personnel are here to assist you with any questions you may have.

Please Like Us On Facebook Page:

<https://www.facebook.com/Big-Top-Party-Rental-336781798960/timeline>

We accept all major credit cards.

