

**BIG TOP PARTY RENTAL**  
36 Hillman Street, Unit 4  
Tewksbury, MA 01876  
(978) 858-0250  
www.bigtoppartyrental.com

Place  
Stamp  
Here

TO:

\_\_\_\_\_  
\_\_\_\_\_  
\_\_\_\_\_  
\_\_\_\_\_



***“Invite us to your next party”***

# BIG TOP

## PARTY RENTAL

TEWKSBURY, MA  
*“Invite us to your next Party”*

***Celebrating Over 30 Years in Business Since 1992***

36 Hillman Street - Unit 4 - Tewksbury, MA 01876

### **2022 PARTY PRICE LIST**

- *Birthdays Parties*
- *Weddings*
- *Graduations*
- *Business Promotions*
- *Tent Sales*
- *Fundraisers*
- *Barbecues*
- *Restaurant Tenting*

*“Not only are Big Top’s prices low, we also deliver and set up. We buy only the finest quality products and equipment.”*

- Party Tents • Tables • Chairs • Dance Floors • Kwik Covers
- Glassware • Dinnerware • Misting Fans
- BBQ Grills • Popcorn & Cotton Candy Machines
- Casino Games • Staging • Coolers • Pipe and Drape
- Christmas Lights Sales and Installations
- Projectors and Projection Screens • Sky Dancers
- Dunk Tanks • Spin Art • & Much More!

Visit our website for more information

[www.bigtoppartyrental.com](http://www.bigtoppartyrental.com)

**Call (978) 858-0250**



Serving all of New England. Located in Tewksbury, MA

Quality • Quantity • Low Rates • Since 1992

*“We Will Gladly Email You An Estimate. It Only Takes A Minute”*

Visit our "Policies and FAQ" page at [www.bigtoppartyrental.com](http://www.bigtoppartyrental.com)

"We at Big Top Party Rental do whatever it takes to satisfy our customers. If something you need is not listed in our price guide don't hesitate to ask. We deliver and set up anywhere, anytime. Consider us your Party Consultants at no extra charge. Thank you for your interest in our company. We will make your party the best."

**Store Hours: 8:30 to 5:00 Monday - Friday**  
**Open some Saturdays during the summer.**

**Big Top Party Rental**

**36 Hillman St., Unit 4 • Tewksbury, MA 01876**

**Phone (978) 858-0250 • Fax (978) 858-0029 • Cell (978) 505-0077**

*\* Please only call cell for after hour emergencies or if you need a rental within 72 hours.*

**www.bigtoppartyrental.com      Email: bigtopparty@comcast.net**

*\*Emailed orders are not accepted due to confirming availability.*

*We accept all major credit cards.*



**Tent Accessories: We Set Up & Deliver**

**TENT SIDEWALLS**

- Sidewalls (White Solid) 20 ft sections ..... 35.00
- Sidewalls (White with Windows) 20 ft sections ..... 35.00
- Sidewalls (White Mesh Screen) 20 ft sections ..... 40.00

**FANS**

- Fan- 12 inch Tent fan ..... 50.00
- Fan - 20 inch (Tri-pod Stand) ..... 70.00
- NEW!** Misting Fan 18" "Cool Caddie" (No Hose Needed, 16 Gallon Tank) ... 149.00
- Big Ass Fan, Sidekick (48" diameter on wheels, 7.5 AMPS) ..... 175.00

**TENT LIGHTING**

- NEW!** Light Dimmer for Tent (Two 7 AMP outlets) ..... 40.00
- Lighting, Perimeter LED for Tents (120 ft per set)) ..... 65.00
- Lighting, LED Floodlight with Remote (18 Colors) ..... 90.00
- Lighting, Par 38 (Tent Flood Light LED) Goes on Center Poles ..... 90.00

**TENT HEATERS**

- Tent Heater (80,000 BTU, Requires Propane) ..... 150.00
- \*12 gauge Extension Cords are recommended for all Fans, Lighting & Heaters.*

**MISCELLANEOUS**

- Barricades (8' 4" x 44"h) ..... 25.00
- Exit Sign (Lights Up) ..... 60.00
- Fire Extinguisher (5 lb. - ABC) ..... 15.00
- \*Refill Charge of \$50 will apply if used*
- Water Barrels (55 or 75 Gallon) ..... 25.00
- Block N' Roll (350 lbs) ..... 30.00
- Block N' Roll (700 lbs) ..... 55.00

**We now offer Bistro Lighting! Call for pricing.**  
**Great for patios, decks, driveways and pool areas!**

**Tents: We Set Up & Deliver**

Don't let the rain or heat stop you from having your party. Stay cool and dry under one of Big Top's tents. **Always allow an additional 10 feet to each dimension for staking.** Visit the "Party Tips" page on our website if you are uncertain of the tent size or space you will need. The prices below include set up. Sidewalls are not included and rented separately.

**ALL WHITE POLE TENTS**

- |                                      |                                      |
|--------------------------------------|--------------------------------------|
| 20' x 20' (40 people)..... 375.00    | 30' x 90' (260 people)..... 1,900.00 |
| 20' x 30' (60 people)..... 475.00    | 30' x 105' (300 people).... 2,300.00 |
| 20' x 40' (80 people)..... 575.00    | 40' x 40' (160 people)..... 1,500.00 |
| 30' x 30' (90 people)..... 900.00    | 40' x 60' (240 people)..... 1,850.00 |
| 30' x 45' (140 people)..... 1,100.00 | 40' x 80' (320 people)..... 2,300.00 |
| 30' x 60' (180 people)..... 1,350.00 | 40' x 100' (400 people).... 2,700.00 |
| 30' x 75' (220 people)..... 1,650.00 | 40' x 120' (480 people).... 3,150.00 |

*\*Pole tents are held up by tension. These tents all have center poles and require anywhere from 12 to 30 stakes per tent. Pole tents can only be set up over grass or pavement. Additional charges will apply if set up on pavement. Call for larger tent sizes.*

**ALL WHITE FRAME TENTS**

- |                                    |                                       |
|------------------------------------|---------------------------------------|
| 10' x 10' (10 people) ..... 250.00 | 20' x 40' (80 people)..... 675.00     |
| 10' x 20' (20 people) ..... 375.00 | 30' x 30' (90 people) ..... 1,100.00  |
| 10' x 30' (30 people) ..... 475.00 | 30' x 45' (140 people)..... 1,850.00  |
| 12' x 12' (15 people) ..... 300.00 | 30' x 60' (180 people) ..... 2,400.00 |
| 15' x 15' (22 people) ..... 400.00 | 30' x 75' (200 people) ..... 2,900.00 |
| 15' x 30' (45 people) ..... 650.00 | 40' x 40' (160 people) ..... 1,800.00 |
| 15' x 45' (60 people) ..... 850.00 | 40' x 60' (240 people) ..... 2,600.00 |
| 20' x 20' (40 people) ..... 475.00 | 40' x 80' (320 people) ..... 3,400.00 |
| 20' x 30' (60 people) ..... 575.00 | 40' x 100' (400 people) ... 4,200.00  |

*\*Frame tents are held up by a pipe structure and require minimal staking. They have no center poles and require anywhere from 4-16 stakes per tent. **Frame tents can be set up on any surface such as grass, pavement, concrete, or patios.** Water barrels can sometimes be used to anchor these tents for those who prefer not to stake. Customer must order water barrels at time of placing order.*

**PINK FRAME TENT **NEW!****

- 20' x 20' Pink Frame Tent (40 People) ..... 475.00
- \*Great for breast cancer awareness events, sweet 16, princess birthdays, showers, and more!*

**EZ-UP CANOPY**

- 10'x10' White Tent (Specify grass or pavement installation when ordering) ..... 125.00

**DO IT YOURSELF PARTY TENTS**

- 16' x 16' (White) ..... 169.00
- \*The "Do It Yourself Tents" are a more affordable tent that we allow our customers to install themselves. We do not offer set up with these tents. All "Do It Yourself Tents" come with easy set up instructions. Two handy people and a 10 pound sledgehammer is all it takes to install these tents! \*DIY tents require grass installation only.*

**“Tables, Chairs, Table Covers, Dance Floors, Staging, Pipe & Drape”**

**TABLES, CHAIRS & UMBRELLAS**

4' Banquet Table 30" x 48" (seats 4-6).....	14.00
6' Banquet Table 30" x 72" (seats 6-8).....	14.00
8' Banquet Table 30" x 96" (seats 8-10).....	14.00
30" x 30" Square Table (specify 30" or 42" height).....	14.00
30" Round Cocktail Table (42" high).....	14.00
36" Round Cocktail Table (42" high).....	14.00
<b>NEW!</b> Table Lamp (Rechargeable, 11", LED) .....	9.00
30" Round Table (seats 2-4 people) .....	14.00
36" Round Table or 3 ft. Round (seats 4-5 people).....	14.00
48" Round Table or 4 ft. Round (seats 4-6 people).....	14.00
60" Round Table or 5 ft. Round (seats 8-10 people).....	14.00
Serpentine Table 30" x 60" (30" high).....	14.00
6' Classroom 18" x 72" .....	14.00
Blue Folding Chairs.....	1.75
White Folding Chairs.....	2.50
<b>NEW!</b> White Resin Garden Chairs.....	4.25
Bar Stool (Black Folding, 28.5" High).....	3.25
Table Umbrella - Green 90" (*Table Not Included) .....	35.00
60" Round Umbrella Table.....	16.00
Riser for Serpentine Table .....	14.00
Riser for 6' Table .....	14.00
<i>*All tables, except children's tables &amp; cocktail tables, are 30" high</i>	



**CHILDRENS TABLES & CHAIRS**

Childrens Table, Blue Plastic (20" height, seats 6-10).....	14.00
Childrens Folding Chair (Blue Plastic, Metal Frame) .....	2.00
Wooden High Chair .....	15.00
Booster Seat.....	8.00

**LINEN TABLE COVERS**

Linen (Over 60 different colors available) .....*Call for Prices and Sizes*

**KWIK COVERS TABLE COVERS**

Kwik Covers (All sizes).....	4.50
Kwik Cover (4ft Fill N' Chill, White) .....	3.00
Kwik Cover (6ft Fill N' Chill, White) .....	4.00
Kwik Cover (Water Barrel) .....	3.50

*\*Our NEW Kwik Covers are reusable or disposable. They are quick & easy to install. These wind proof elastic corners hold table cover on tight without using tacks, staples or tape. We always stock white, for additional colors, please call.*

**DANCE FLOORS**

Parquet 4' x 4' Sections: Indoor..... 30.00 Outdoor..... 32.00  
*\*We can create any size that you desire. Email us for a list of sizes and prices.*

**STAGING**

4' x 4' Sections (9"-24" high) .....	38.00	<i>*Our staging can be adjusted between 9"-24" high. Please specify when ordering.</i>
Stairs w/ rail.....	38.00	<i>Stairs and Skirting are rented separately.</i>
Stage Step .....	30.00	
Stage Skirting (Black - 8' X 15' or 24' Sections) ...	10.00	

**“Food Machines are a great addition to any event or Fundraiser”**

**FOOD MACHINES**

*We do not require you to clean any of our food machines after you use them. Leave us the mess at no extra charge!*

Coffee Maker (60 cups).....	25.00
Cupcake Tower (26" tall, Round, 2-5 tiers, holds up to 140) ...	28.00



Cotton Candy Machine .....

Cotton Candy Supplies (per 50) .....

*\*Cotton Candy supplies come with bags, cones and sugar (blue or pink)*

Cotton Candy Pre-made Bags (9" X 13" cello bag) .....

*\*Great if you don't want to rent the machine. Available in Pink or Blue.*



Cotton Candy Cart..... 30.00

Frozen Beverage Machine (1 Bowl Unit)..... 145.00

*\*Frozen Beverage Supply pricing is available by email or calling our office. We have Strawberry Daiquiri, Blue Raspberry, Margarita and Pina Colada available.*



Hot Dog Steamer (holds 80) .....



Lemon Squeezer..... 25.00

*\*Ask about our Lemonade Stand!*



Pizza Warmer (18" x 18" x 30") .....

*\*Holds up to (4) Large Pizzas; includes pans.*

Pizza/Pretzel Combo Unit .....

*\*Holds (2) Pizzas and up to (20) Pretzels.*

Popcorn Machine .....

Popcorn Machine supplies (per 50) Bags, oil & seed.....

Popcorn Machine supplies (per 50) Boxes, oil & seed.....

Popcorn Cart .....



Pretzel Warmer (18" x 18" x 30") .....

*\*Holds up to (50) Pretzels!*



Snowie, 1000 Model..... 65.00

Snowie Supplies (per 25) .....

*\*Snowie supplies come with 25 cups, spoon straws & 2 flavors. Ice not included.*

*Ask about our available flavors. Extra Flavors are \$9.50 (32oz. bottle).*

Extension Cords (100 feet, 12 gauge, 3 prong white cord) .....

**IMPORTANT:** We recommend you only use a 12 gauge, 3 prong extension cord with any of our food machines. Do not use more than a 100 feet of extension cord or machine may not work properly. We do have extension cords available for rental. We also strongly recommend not using any splitters or adapters.

**"Cookout & BBQ Equipment"**

**COOLERS & BEVERAGE SERVERS & WARMERS**

Beverage Dispenser (5 Gallon) ..... 22.00  
*\*Our Beverage Dispensers are great for lemonade, iced tea, hot chocolate, punch, hot or cold water. Green, Black and Blue colors available.*



**NEW!** Cambro 4-Pan Food Warmer, Black (Holds 4 pans)..... 40.00

Coffee Carafe, 40 oz ..... 3.50

Fill N' Chill Party Table, 6ft Black (Holds 75-100lbs of ice) ..... 30.00

Fill N' Chill Party Table, 4ft White (Holds 35-50lbs of ice)..... 24.00

*\*Keeps salads, drinks, dessert, and meats cold and fresh! Skirting is rented separately. Ask about Kwik Covers!*

**NEW!** Fill N' Chill Skirting and Skirt Clips ..... 12.00

Lemonade Bar/Stand ..... 150.00

*\*Includes Umbrella, (2) 18 Quart Coolers, Cutting Board and Bottle Opener*

Marine Cooler, White (102 Qt) ..... 24.00

*\*Our Marine coolers are great for keeping food, ice or drinks cold. Holds over 150 cans.*

Portable Bar ..... 95.00

Super Coolers ..... 20.00

*\*Holds 7 cases of cans or any size keg. Only needs 3-4 bags of ice!*



**GRILLS & COOKERS**

Chafing Dishes, Half Size 4 Qt ..... 22.00

Chafing Dishes, Full Size 8 Qt ..... 27.00

*Additional Food Pans available, 4 qt .....4.50, 8 qt..... 7.00*

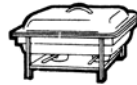

Chafing Dish Roll Top, Full Size 9 Qt..... 55.00

Sternos for Chafing Dishes(1 can per every 4 Qt)..... 2.25

Charcoal Grill (2 x 5, charcoal not included)..... 95.00

Gas Grill (2 x 4, propane not included) ..... 145.00

Grill Kit (Tongs, Spatula, Lighter, Cleaning Brush, & Fork) .....9.00

Pot, Basket & Lid (60 Qt) ..... 25.00

Single Burner Pot Cooker (propane not included) ..... 22.00

Gas Griddle (propane & fire extinguisher not included) .. 130.00



**"Propane Tank Rental Prices Are On Miscellaneous Page"**

*\*All of our Coolers, Chafing Dishes, Pots, Portable Bars and Beverage Dispensers must be returned reasonably clean. A service charge will apply if any of these items are returned not clean.*

**DUNK TANKS & BIG SPLASH**

Dunk Tank Purple ..... 250.00

*\*Our Dunk Tanks holds 500 gallons of water and takes roughly about 30-40 minutes to fill.*

**NEW!** Big Splash (A great substitution for the Dunk Tank) ... 175.00

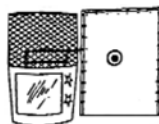

Dunk Tank

**"Games, Trade Shows & Fundraising Items"**

**GAMES**

**NEW!** Cornhole Game (visit our website for more info)..... 50.00

**NEW!** Hole in One Golf Game ..... 110.00

**NEW!** Jumbo Beer Pong..... 30.00

*\*Includes (12) Buckets, (2) balls & Carry Case.*

**NEW!** Jumbo Jenga ..... 50.00

Jumbo Connect 4 ..... 50.00

Limbo Game (rack with music CD) ..... 30.00

Potato Sack Race Set ..... 30.00

Spin Art Machine ..... 65.00

Spin Art Supplies (per 50) ..... 37.50

Tug of War Game ..... 25.00

Mini Hoops ..... 50.00

Ring Toss ..... 50.00

Tic Tac Toss ..... 50.00

*\*Recommended ages for Ring Toss, Tic Tac Toss & Mini Hoops is 12 and under.*

**"For A List Of Casino Games See Page 9"**

**TRADE SHOW & FUNDRAISING ITEMS**

Raffle Drum..... 22.00

Raffle Tickets (2000 per roll) ..... 8.00

Prize Wheel – Table Top (30" Diameter) ..... 79.00

*\*12 customizable prize slots. Dry erase or insert.*

**NEW!** Easel (Aluminum, Telescopic, Folding, 64 ¼" H)..... 14.00

**PIPE, DRAPE & STANCHIONS**

Base Plates (15" x 15" Screw In, 12lbs).....5.00

Base Plates (18" x 18" for Adj. Uprights, 18lbs) .....9.00

Base Weight (25lbs) ..... 16.00

Uprights: 8 Ft High (Screw in)..... 5.00 3 Ft High (Screw in) .....5.00

Adjustable (6'-10') ..... 15.00 2 Ft Upright Extender .4.00

Crossbars (6', 8', or 10' Adjustable) .....5.00

Sign Hooks for Crossbars (Pack of 10).....2.00

*For pricing and colors of drape please call our office.*

Red Carpet (4' x 25') .....99.00 Red Carpet (4' x 36')..... 130.00

*\*Security Deposit Required on all Red Carpet rentals.*

Stanchions, Chrome Base..... 12.00 Stanchions, Rope 8' Velvet.....9.00

Stanchions, Black..... 10.00 Stanchion Sign Holder .....8.00

**HELIUM TANKS & BALLOONS (Helium prices subject to change)**

Helium Tank - 20 Cubic Foot (50-70 Balloons) ..... 67.00

Helium Tank - 40 Cubic Foot (80-140 Balloons) ..... 107.00

Helium Tank - 80 Cubic Foot (160-280 Balloons) ..... 159.00

*\*Visit our web site for larger sizes. Balloons and Regulator are Not included.*

Helium Assortment Pack 50 (9 inch) ..... 16.50

*\*Comes with 1 roll 3/16 White Ribbon. Jewel Assorted 9 inch Balloon colors are Red, Blue, Green, Yellow & Orange.*

Helium Regulator (no gauge).... 5.00 Helium Regulator (gauge) ..... 12.00

Balloon Ribbon (3/16, White)..... 4.00

**CASINO GAMES**

- Have us set up a mini casino at the home or office!*
- Black Jack Table with Accessories ..... 120.00  
*\*Black Jack Accessories come with 6 decks of cards, dealers shoe, discarder & chips.*
- Craps Table with Accessories..... 120.00  
*\*Craps Table Accessories come with 5 dice, dice stick, on/off puck & chips.*
- Roulette Table with Accessories..... 120.00  
*\*Roulette Table Accessories come with wheel, ball, win indicator & chips.*
- Chuck-A-Luck/Grand Hazard ..... 49.00  
*\*Chips rented separately.*
- Casino Package ..... 299.00  
*\*Casino Package includes Black Jack, Craps & Roulette Tables with Accessories.*
- Case of Chips ..... 16.00  
*\*Chips come in \$1, \$5, \$10 & \$25 denominations. A total of 125 chips for each denomination totaling \$5,125 per case.*



All Casino Accessories are rental items and must be returned.

**SOUND SYSTEMS**

-  Bose Wireless Speaker (bluetooth, rechargeable 11-hour battery) ..... 75.00
- Podium or Lectern (needs electricity or two 6V batteries) ..... 90.00  
*\*Batteries not included.*
- Fender P-150 PA Sound System (150 watt) ..... 70.00  
*\* Our Fender is very easy to use. Speakers, microphone, amp and mixer all in one. Hook up to any iPod or Laptop! Additional cable for hook up rented separately.*
- iPOD or Laptop Mini Stereo to Dual RCA Cable ..... 3.00
- RCA Cable (9 feet) ..... 3.00
- Yamaha MSR400 Sound System (800 watt)..... 195.00
- Speaker Stands ..... 10.00

*Use only 12 gauge, 3 prong extension cords with all visual, microphone, and sound systems*





**MICROPHONES**

- Microphone Stand ..... 10.00
- Microphone with Wire ..... 6.00
- Wireless Handheld Microphone System ..... 45.00
- Wireless Lapel Microphone System ..... 50.00

**VISUAL & EFFECTS**



- DVD Player..... 25.00
- Projection Screen – 6 foot (indoor screen)..... 70.00
- Projection Screen – 10 foot (indoor screen)..... 110.00
-  Projector – Sanyo PLC-XC55 Ultra Portable LCD ..... 125.00
- Projector – Panasonic PT-VZ580U - 5000 Lumen ..... 125.00
- Roto Balls..... 25.00  
*\*2 Multi-colored balls that spin and rotate to create 104 rich saturated razor sharp beams of light. Visit our website for a demonstration.*

**SKY DANCERS**

- Santa Air Puppet, 20' ..... 125.00
-  Elf Air Puppet, 20' ..... 125.00
- "Now Open" Air Puppet (red with yellow print) ..... 90.00
- Air Puppet, 20' Plain..... 90.00  
*\*Colors available: Red, Yellow, Fluorescent Green, Light Blue, and Royal Blue*
-  Big Top Party Air Puppet, 20' (Blue with Yellow Print) ..... 70.00
- Bride Air Puppet, 18' ..... 110.00
- Congratulations Air Puppet, 20' ..... 90.00
- Corona Air Puppet, 20'..... 90.00
-  Ghost Air Puppet, 18' (Lights up LED) ..... 90.00
- Grand Opening Air Puppet, 20' ..... 90.00
- Groom Air Puppet, 18' ..... 110.00
- Happy Birthday Air Puppet, 20' ..... 90.00
- Sale Air Puppet, 20' Blue ..... 90.00
-  Welcome Home Air Puppet, 20' ..... 90.00

*\* Blowers are included with each Sky Dancer Rental. Extension cords are additional. All prices are based on 2 days use. Sky Dancers should not be used in rain or severe winds. If you need a blower for your own Sky Dancer, we do rent them.*

**MISCELLANEOUS ITEMS**











- Ceremonial Ribbon (Red, 4" wide, 20' long) ..... 12.00
-  Ceremonial Scissors (Silver Plated, Black Handle, 25" long) ..... 39.00
- Coat Rack, Single Rail Collapsible (Holds 40-60 garments) ..... 20.00
- Coat Hangers (Pack of 10) ..... 2.00
- Coat Check Tickets (Pack of 50) ..... 6.00
- Generator (2,000 Watt, Quiet) Honda EU2200i ..... 59.00
-  Generator (3,000 Watt, Quiet) Honda EU3000is ..... 99.00
- Generator (7,000 Watt, Quiet) Honda EU7000IAT1 ..... 165.00

*\*All of our generators take unleaded fuel.*

- Podium or Lectern (needs electricity or two 6V batteries) ..... 90.00  
*\*Batteries not included.*
- Propane Tanks: 20 lb .... 23.00    40 lb ..... 39.00    100 lb ..... 99.00
- Trash Barrels - 32 Gallon (comes with 1 liner)..... 13.00
- Disposable Trash Box - (55 Gallon liner included) ..... 12.00
- Smoker's Receptacle ..... 60.00

**“Glassware, Dinnerware, and Flatware”**

**GLASSWARE**

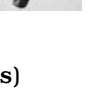
All Purpose Goblet (Water), 14 oz, (25 Per Rack) .....	15.00	
Champagne Flute, 5.75 oz, (36 Per Rack) .....	22.00	
Highball (Beverage Glass), 12.5 oz, (36 Per Rack) .....	20.00	
Martini (Cocktail), 10 oz, (12 Per Rack) .....	15.00	
Rocks Glass, 9 oz, (25 Per Rack) .....	15.00	
Tall Wine, 8.5 oz, (25 Per Rack) .....	15.00	
Tall Wine, 12 oz, (25 Per Rack) .....	15.00	
Irish Coffee, 10 oz (25 Per Rack) .....	15.00	
Water Pitcher, Glass 55 oz (5 Per Rack) .....	20.00	
Water Pitcher, Glass 55 oz (Individual) .....	5.00	
Shot Glass 2.5 oz (49 per pack) .....	24.50	

*All of our glassware is fully tempered to be durable and safe!*

**DINNERWARE**

Classic White Rim Collection

Classic Dinner Plate, 10¼” (20 Per Rack) .....	15.00
Salad/Dessert Plate, 8¾” (30 Per Rack) .....	18.00
B&B/Appetizer Plate, 6” (38 Per Rack) .....	20.00
Coffee Cup, 8 oz (20 Per Rack) .....	12.00
Saucer, 6” (44 Per Rack).....	24.00
Soup/Salad Bowls, 9 oz (packs of 10).....	10.00



White Square Collection

Artisan Square Dinner Plate, 10½” (20 Per Rack) ....	20.00
Salad/Dessert Plate, 8½” (21 Per Rack) .....	17.00
Bread & Butter/Appetizer Plate, 6” (44 Per Rack) ....	30.00
Coffee Cup, 7 oz (20 Per Rack).....	16.00
Saucer, 5” (38 Per Rack) .....	25.00
Platter, 15¾” x 9¾”, Porcelain (Individual) .....	3.00



**FLATWARE** - Each pack of 10 ...6.50

Dinner Fork (Pack of 10)	Dinner Spoon (Pack of 10)
Salad Fork (Pack of 10)	Soup Spoon (Pack of 10)
Dinner Knife (Pack of 10)	Table Spoon (Pack of 10)
Oyster Fork (Pack of 10)	Butter Knife (Pack of 10)



**SERVING ACCESSORIES**

Lobster Shell Cracker .....	1.00	Dolly (Tan, plastic w/ wheels)	8.00
Coffee Carafe, 40 oz, White (5 Per Rack) .....	17.50	Holds 4-6 Rack.....	8.00
Bread Basket, 9” x 2¾”, Round, Woven Poly, Natural Wood Color..	2.50	Cambro 4-Pan Food Warmer, Black (Holds 4 pans).....	40.00
Salt & Pepper Shaker set .....	1.50	Ramekins, 2 1/2 oz (each) .....	1.00
Serving Tray, Silver, 18” Round	12.00	Chafing Dish, Half Size 4 Qt....	22.00
Tray (Oval 22” x 27”) Black.....	15.00	Chafing Dish, Full Size 8 Qt ....	27.00
Tray Stand (Chrome).....	14.00	Chafing Dishes, Roll Top Full Size 9 Qt .....	55.00
Water Pitcher, Glass 55 oz .....	5.00	Sternos (8 qt needs 2 cans) .....	2.25
		Tongs (12 inch) .....	2.00

*If you are searching for something not on this list, just ask!*

**“Invite Us To Your Next Party”**

**About Our Rental Services**

We recommend you reserve the items you need as soon as possible to ensure they will be available. Delivery charges apply for qualifying orders and vary according to distance. We also have items available for customer pick up at our location in Tewksbury. Please do not email any orders. Emailed orders are not accepted as we must check rental item availability and take a down payment at the time your reservation is placed.

Responsibility for equipment remains with customer from time of possession until time of return. Prices are quoted for one day’s use. There are shorter and longer rates available; please call for details. There will be a charge for items not returned clean and for missing or broken items. We do not require you to clean any of our food machines after you use them, however, we do require that food machines be returned empty.

Supplies for spin art, popcorn machines, casino games, chocolate fountains, cotton candy machines, Snowie machines, frozen beverage machines, coffee makers, and any other food machines are sold separately. Propane for grills, patio and tent heaters is also sold separately.

An extra charge will apply for any tent used on asphalt. We must be told at time of reservation what surface any tent will be used on because of staking concerns. Only grass or asphalt areas are acceptable. Decks or concrete surfaces are most times not acceptable. When renting tables, chairs, pipe and drape, a service charge of 25% may apply for set up.

**Reservation and Cancellation Policy**

**Reservations:** A 50% non-refundable down payment is due at the time of reservation on orders placed more than 30 days before the event date. Final payment is due prior to delivery or installation. Full payment is due at the time of booking for all orders placed within 30 days of the event date AND orders with a subtotal under \$300.

**Cancellations:** All sales are final and non-refundable on orders placed within 30 days of the event date. No refunds will be granted in the event of rain or inclement weather. Rental contracts may not be terminated by the customer within 30 days of the event date. If customer cancels 31 days or beyond they will be obligated to pay 50% of rental contract total and a \$50-100 processing fee will also apply.

**Order Adjustments (Order Changes):** Any quantity reductions or adjustments on rental equipment shall not be valid if not received prior to 30 days before the event date. Any order changes must be submitted to BTPR by email and are subject to availability and our Terms and Conditions. We need 3 weeks’ notice of all reasonable order adjustments (a 25% fluctuation is considered reasonable) regardless of when order is placed. Linen orders (including color selection) cannot be changed or adjusted if less than two weeks from your event date.

If you need any further clarification regarding our policies, please contact us at 978-858-0250. Our customer service personnel are here to assist you with any questions you may have.

*Please Like Us On Facebook Page:*

<https://www.facebook.com/Big-Top-Party-Rental-336781798960/timeline>

*We accept all major credit cards.*

